

KR Electronics 2530 Bandpass Filter

General Description

KR 2530 is a 518 MHz surface mount bandpass filter. Other center frequencies and bandwidths available. Please consult the factory.

Features

- Surface Mount Package
- 518 MHz Center Frequency
- BW_{1dB} 80 MHz min
- >40 dB Stopband
- 50 Ω Source and Load

Typical Performance

Passband Amplitude & Group Delay
(1 dB/div & 2 nsec/div)

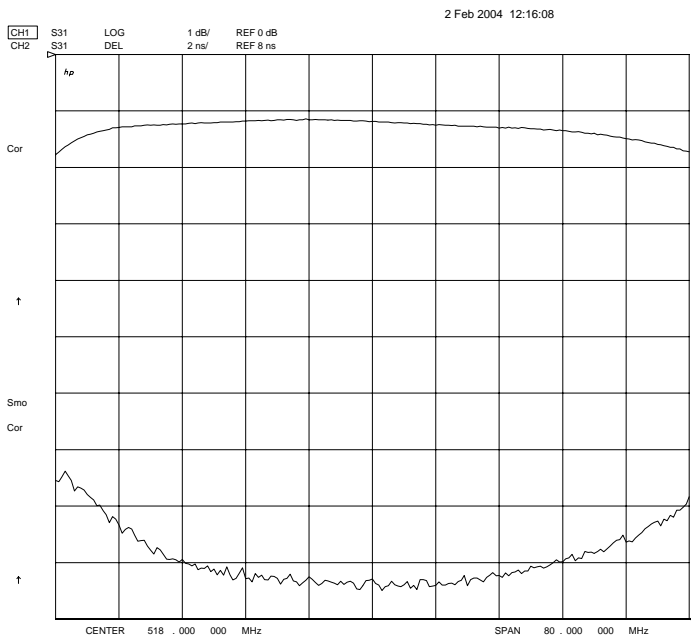

Overall Response
(10 dB/div)

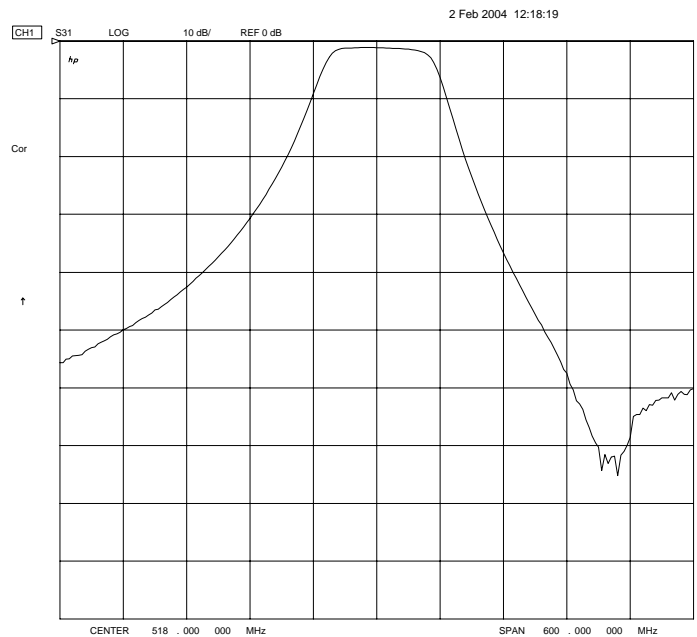

KR Electronics, Inc.
91 Avenel Street
Avenel, NJ 07001

Web www.krfilters.com
Email sales@krfilters.com
Phone (732) 636-1900
Fax (732) 636-1982

KR Electronics 2530 Bandpass

Specifications

Parameter	Specification
Filter type	Bandpass
Center Frequency	518 MHz
Insertion Loss	< 3 dB (1.5 dB Typical)
Attenuation at 300 MHz	> 40 dB
Attenuation at 478 MHz	< 1 dB
Attenuation at 558 MHz	< 1 dB
Attenuation at 770 MHz	> 40 dB
Source and Load	50 Ω

Physical Dimensions

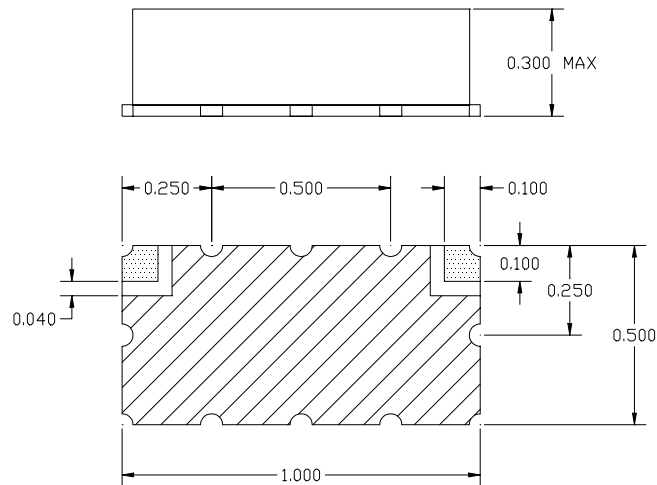

Notes:

1. Surface mount package — Metal cover, open frame
2. Dimensions in inches
3. Use SN60 or SN63 solder during installation
4. If boards are cleaned after installation, units must be completely dried to remove any entrapped moisture that will effect electrical performance